



LEMOEN SERIES 5KWH User Manual



Wall Mount LiFePO4 Battery

- Advanced BMS with current limiting function
- CAN Bus, fully integrates and communicates with leading Inverter brands (DEYE, Sunsynk, Victron, Growatt, SOLAX, LUXPower, MUST, Voltronic, SMA...etc.)
- Excellent high temperature performance
- High Cycle Life and Service Life
- 1C High Performance Lithium battery
- High Energy Density and conversion efficiency
- Complete with integrated Battery Management System
- Compatible with most Inverters and chargers
- Low self discharge
- Easy wall mount installation
- Heavy duty side handles for easy handling and mounting on the wall
- Built in protection for over-charge, over-discharge & over-temperature

Content

Statement of Law	1
Safety Precautions.....	2
Preface.....	3
1 Introduction.....	4
1.1 Brief Introduction.....	4
1.2 Product Properties.....	4
1.3 Product identity definition.....	5
2 Product Specification.....	6
2.1 Size and Weight	6
2.2 Performance Parameter	6
2.3 Interface Definition.....	6
2.3.1 DIP switch definition and description	7
2.4 Battery Management System(BMS)	10
2.4.1 Voltage Protection	10
2.4.2 Current Protection	10
2.4.3 Temperature Protection	10
2.4.4 Other Protection	11
3 Installation and Configuration	12
3.1 Ready for installation	12
3.1.1 Environmental requirements	12
3.1.2 Tools and data.....	12
3.1.3 Technical preparation	13
3.1.4 Unpacking inspection	13
3.1.5 Engineering coordination.....	14
3.2 Equipment installation.....	14
3.2.1 Installation preparation	14-16
4 Communicate inverter.....	17
4.1 Method 1:Communicat factory default inverters	17
4.2 Method 2:Communicate optional inverters(protocol select).....	17
4.3 Remark of inverter protocol code.....	17

Statement of Law

Copyright of this document belongs to Lemoen ®

No documentation maybe excerpted, reproduced, translated, annotated or duplicated in any form or by any means without the prior written permission of Lemoen ® or its duly authorized agents. All Rights Reserved.

This product complies with the design requirements of environmental protection and personal safety. The storage, use and disposal of the products shall be carried out in accordance with the product manual, relevant contract or relevant laws and regulations.

Customer can check the related information on the website : www.lemoen.tech

Please note that the product / document can be modified without prior notice.

Safety Precautions



Warning

- Please do not put the battery into water or fire, in case of explosion or any other situation that might endanger your life.
- Please connect wires properly while installation, do not reverse connect.
To avoid short circuit, please do not connect positive and negative poles with conductor (Wires for instance).
- Please do not stab, hit, trample or strike the battery in any other way.
- Please shut off the power completely when removing the device or reconnecting wires during the daily use or it could cause the danger of electric shock.
- Please use dry powder extinguisher to put out the flame when encountering a fire hazard, liquid extinguisher could result in the risk of secondary disaster.
- For your safety, please do not arbitrarily dismantle any component in any circumstances unless a specialist or an authorized one from our company, device breakdown due to improper operation will not be covered under warranty.



Caution

- We have strict inspection to ensure the quality when products are shipped out, however, please contact us if case bulging or another abnormal phenomenon.
- For your safety, device shall be ground connected properly before normal use.
- To assure the proper use please make sure parameters among the relevant device are compatible.
- **Please do not mixed-use batteries from different manufacturers, different types and models, as well as old and new together.**
- Ambient and storage method could impact the life span and product reliability, please consider the operation environment abundantly to make sure device works in proper condition.
- For long-term storage, the battery should be recharged once every 6 months, and the amount of electric charge shall exceed 80% of the rated capacity.
- Please charge the battery in 18 hours after it discharges fully and starts over-discharging protection.
Formula of theoretical standby time: $T=C/I$ (T is standby time, C is battery capacity, I is total current of all loads).

Preface

Manual declaration

The Lemoen lithium iron phosphate battery energy storage system can provide energy storage solutions for photovoltaic power generation users through parallel combination. During the day, the excess power of photovoltaic power generation can be stored in the battery. At night or when needed, the stored electrical energy can be used to supply power to the electrical equipment, which can improve the efficiency of photovoltaic power generation, peak load shifting, and emergency power backup.

This user manual details the basic structure, parameters, basic procedures and methods of installation and operation and maintenance of the equipment.

1 Introduction

1.1 Brief Introduction







Lemoen lithium iron phosphate battery system is a standard battery system unit, customers can choose a certain number of lemoen according to their needs, by connecting parallel to form a larger capacity battery pack, to meet the user's long-term power supply needs. The product is especially suitable for applications with high operating temperatures, limited installation space, long power backup time and long service life.

1.2 Product Properties

Lemoen energy storage product's anode materials are lithium iron phosphate, battery cells are managed effectively by BMS with better performance, the system's features as below:

- Comply with European ROHS, Certified SGS, employ non-toxic, non-pollution environment-friendly battery.
- Anode materials are lithium iron phosphate (LiFePO₄), safer with longer life span.
- Carries battery management system with better performance, possesses protection function like over-discharge, over-charge, over-current, abnormal temperature.
- Self-management on charging and discharging, Single core balancing function.
- Flexible configurations allow parallel of multi battery for longer standby time.
- Self-ventilation with lower system noise.
- Less battery self-discharge, then recharging period can be up to 10 months during the storage.
- No memory effect so that battery can be charged and discharged shallowly.
- With wide range of temperature for working environment, -20°C ~ +65 °C, circulation span and discharging performance are well under high temperature.
- Less volume, lighter weight.

1.3 Product identity definition

	<p>Be careful with your actions and be aware of the dangers.</p>
	<p>Read the user manual before using.</p>
	<p>The scrapped battery cannot be put into the garbage can and must be professionally recycled.</p>
	<p>After the battery life is terminated, the battery can continue to be used after it recycled by the professional recycling organization and do not discard it at will.</p>
	<p>This battery product meets European directive requirements.</p>
	<p>Battery voltage is higher than safe voltage, direct contact with electric shock hazard.</p>
<div style="border: 1px solid black; padding: 5px;"> <p style="text-align: center; color: white; background-color: red; margin: 0;">DANGER</p> <p style="text-align: center; font-size: 8px; margin: 0;">HIGH VOLTAGE BATTERY</p> <div style="display: flex; align-items: flex-start;"> <div style="flex: 1;">  </div> <div style="flex: 2; font-size: 8px;"> <ul style="list-style-type: none"> * Do not disassemble, disassemble or repair by yourself. * Do not drop, deform, impact, cut or squaring with a sharp object. * Do not place near open flame or induction. * Do not cut or put heavy things on battery. * Keep away from moisture or liquid. * Keep out of reach of children, animals or insects. * Contact the supplier within 24 hours if anything wrong. <p>Emergency Situations</p> <ul style="list-style-type: none"> * If smoking, fire, wet or damaged, switch off the breaker and go away from the battery. * Do not touch the leaking liquid. Do not use water, sand or dry powder extinguisher to smother. </div> </div> </div>	<p>Dangerous goods warning label on the top of the battery module.</p>

2 Product Specification

2.1 Size and Weight

Table 2-1 Device size

Product	Nominal Voltage	Nominal Capacity	Dimension	Weight
Lemoen Life5	DC51.2V	100Ah	550×630×110mm	≈45kg

2.2 Performance Parameter

Table 2-2 Performance parameter

Item	Parameter value
Nominal Voltage(V)	51.2
Work Voltage Range(V)	44.8~56
Nominal Capacity(Ah)	100
Nominal Energy(kWh)	5.12
C Rating	1.0
Charge Voltage(V)	55.2-56
Discharge Cutoff Voltage(V)	44.8
Equilized Charge Voltage(V)	56
Max. Continuous Charging Current(A)	100
Max. Continuous Discharging Current(A)	100

2.3 Interface Definition

This section elaborates on interface functions of the front interface of the device.

Top View

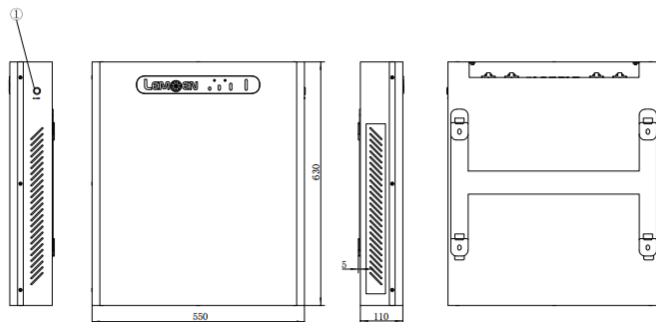

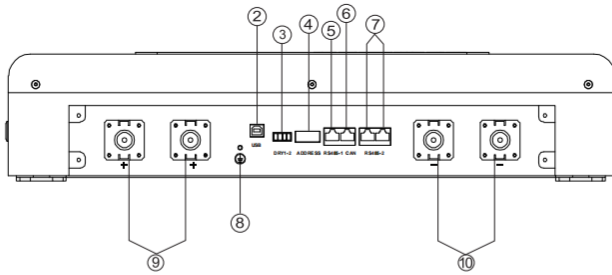

Item	Name	Definition
1	Power switch	OFF/ON, must be in the "ON" state when in use
2	USB	/
3	DRY CONTACT	/
4	ADD	DIP switch
5	RS485	Communication cascade port, support RS485 communication
6	CAN	Communication cascade port, support CAN communication (factory default CAN communication)
7	RS485-2	Battery parallel connection ports
8	GRID	/
9	Positive socket	Battery output positive or parallel positive line
10	Negative socket	Battery output negative or parallel negative line

2.3.1 DIP switch definition and description

Table 2-4 Interface Definition

DIP switch position (host communication protocol and baud rate selection)			
#1	#2	#3	#4
Baud rate selection			
ON		OFF	
CAN: 250K,485: 9600		CAN: 500K,485: 9600	

DIP switch description:

When the battery pack is connected in parallel, the host can communicate with the slave through the CAN interface. The host summarizes the information of the entire battery system and communicates with the inverter through CAN or 485. The connection mode is divided into the following two cases:



Address	Codes the switch position			
	#1	#2	#3	#4
1	OFF	OFF	OFF	OFF
2	ON	OFF	OFF	OFF
3	OFF	ON	OFF	OFF
4	ON	ON	OFF	OFF
5	OFF	OFF	ON	OFF
6	ON	OFF	ON	OFF
7	OFF	ON	ON	OFF
8	ON	ON	ON	OFF
9	OFF	OFF	OFF	ON
10	ON	OFF	OFF	ON
11	OFF	ON	OFF	ON
12	ON	ON	OFF	ON
13	OFF	OFF	ON	ON
14	ON	OFF	ON	ON
15	OFF	ON	ON	ON
16	ON	ON	ON	ON

Table 5 Dial switch position

Table 2-4 Pin Definition

RS485-1 / CAN Communication Interface Definition:

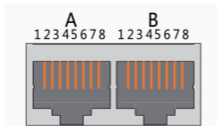

Interface	Defined declaration		Defined declaration			
X1 Communication port definition	A part CAN joggle	PIN 1	CANL	B part RS-485-1 Interface	PIN 1	RS485-B1
		PIN 2	CGND		PIN 2	RS485-A1
		PIN 3	NC(empty)		PIN 3	RS485-GND
		PIN 4	CANH		PIN 4	RS485-B1
		PIN 5	CANL		PIN 5	RS485-A1
		PIN 6	NC(empty)		PIN 6	RS485-GND
		PIN 7	CGND		PIN 7	NC(empty)
		PIN 8	CANH		PIN 8	NC(empty)

Table 7 The RS 485-1 / CAN port definition

Table 2-5 LED status indicators

State	Normal / alarm / protection	RUN	ALM	The power level indicates the LED				Explain
		●	●	●	●	●	●	
Shut down	Dormancy	off	off	off	off	off	off	All off
Standby	Normal	Flash 1	off	According to the electricity instruction				Stand by
	Alarm	Flash 1	Flash 3					Module low voltage
Charge	Normal	Lighting	off	According to the electricity instruction (Power level indicates maximum LED flash 2)				Alarm when overvoltage light off
	Alarm	Lighting	Flash 3					
	Overcharge protection	Lighting	off	Lighting	Lighting	Lighting	Lighting	If there is no charging, the indicator light is in standby state
	Temperature, overcurrent, protection	off	Lighting	off	off	off	off	Stop charging
Discharge	Normal	Flash 3	off	According to the electricity instruction				
	Alarm	Flash 3	Flash 3					
	Undervoltage protection	off	off	off	off	off	off	Stop discharge
	Temperature, over-current, short-circuit, Reverse connection and failure protection	off	Lighting	off	off	off	off	Stop discharge
Fail		off	Lighting	off	off	off	off	Stop charging and discharging

Table 1 LED working status indication

State	Capacity indicator light	Charge				Discharge			
		L4	L3	L2	L1	L4	L3	L2	L1
Battery Power(%)	0 ~ 25%	off	off	off	Flash 2	off	off	off	Lighting
	25 ~ 50%	off	off	Flash 2	Lighting	off	off	Lighting	Lighting
	50 ~ 75%	off	Flash 2	Lighting	Lighting	off	Lighting	Lighting	Lighting
	75 ~ 100%	Flash 2	Lighting	Lighting	Lighting	Lighting	Lighting	Lighting	Lighting

Table 2 Capacity indication instructions

Flash mode	Bright	off
Flash, 1	0.25S	3.75S
Flash, 2	0.5S	0.5S
Flash, 3	0.5S	1.5S

2.4 Battery Management System(BMS)

2.4.1 Voltage Protection

Discharging Low Voltage Protection :

When any battery cell voltage is lower than the protection value during discharging, The over-discharging protection starts, and the battery buzzer makes an alarm sound. Then battery system stops supplying power to the outside. When the voltage of each cell recovers to rated return range, the protection is over.

Charging Over Voltage Protection :

When total voltage or any battery cell voltage reaches the protection value during charging, battery stops charging. When total voltage or a cell recover to rated return range, the protection is over.

2.4.2 Current Protection

Over Current Protection in Charging :

When the charging current is greater than the protection value, the battery buzzer alarms and the system stops charging. Protection is removed after rated time delaying.

Over Current Protection in Discharging :

When the discharge current is greater than the protection value, the battery buzzer alarms and the system stops discharging. Protection is released after rated time delaying.



Note:

The buzzer sound alarm setting can be manually turned off on the background software, and the factory default is on.

2.4.3 Temperature Protection

Less/Over temperature protection in charging :

When battery's temperature is beyond range of 0 °C ~+65 °C during charging, temperature protection starts, device stops charging.

The protection is over when it recovers to rated return range.

Less/Over temperature protection in discharging :

When battery's temperature is beyond range of -20 °C ~+65 °C during discharging, temperature protection starts, device stops supplying power to the outside.

2.4.4 Other Protection

Short Circuit Protection :

When the battery is activated from the shutdown state, if a short circuit occurs, the system starts short-circuit protection for 30 seconds.

Self-Shutdown :

When device connects no external loads and power supply and no external communication for over 72 hours, device will dormant standby automatically.



Caution

Battery's maximum discharging current should be more than load's maximum working current.

3 Installation and Configuration

3.1 Ready for installation

Safety Requirement

This system can only be installed by personnel who have been trained in the power supply system and have sufficient knowledge of the power system.

The safety regulations and local safety regulations listed below should always be followed during the installation.

- All circuits connected to this power system with an external voltage of less than 48V must meet the SELV requirements defined in the IEC60950 standard.
- If operating within the power system cabinet, make sure the power system is not charged. Battery devices should also be switched off.
- Distribution cable wiring should be reasonable and has the protective measures to avoid touching these cables while operating power equipment.
- when installing the battery system, must wear the protective items below:



The isolation gloves



Safety goggles



Safety shoes

Figure3-1

3.1.1 Environmental requirements

Working temperature: -20 °C ~ +55 °C

- Charging temperature range is 0°C~+55 °C,
- Discharging temperature range is -20 °C ~+55 °C

Storage temperature: -10 °C ~ +35 °C

Relative humidity: 5% ~ 85%RH

Elevation: no more than 4000m

Operating environment: Indoor installation, sites avoid the sun and no wind, no conductive dust and corrosive gas.

And the following conditions are met:

- Installation location should be away from the sea to avoid brine and high humidity environment.
- The ground is flat and level.
- There is no flammable explosive near to the installation places.
- The optimal ambient temperature is 15°C ~ 30 °C
- Keep away from dust and messy zones

3.1.2 Tools and data

Hardware tool

Tools and meters that may be used are shown in table 3-1.

Table 3-1 Tool instrument

Name	
Screwdriver (word, cross)	AVO meter
Wrench	Clamp meter
Inclined pliers	Insulating tape
Needle nose pliers	The thermometer

Name	
Clip forceps	Wrist strap
Wire stripper	AVO meter
Electric drill	Tape

3.1.3 Technical preparation

Electrical interface check

Devices that can be connected directly to the battery can be user equipment, power supplies, or other power supplies.

- Confirm whether the user's PV power generation equipment, power supply or other power supply equipment has a DC output interface, and measure whether the DC power output voltage meets the voltage range requirements in Table 2-2.
- Confirm that the maximum discharge current capability of the DC power interface of the user's photovoltaic power generation equipment, power supply or other power supply equipment should be greater than the maximum charging current of the products used in Table 2-2.

If the maximum discharge capacity of the DC power interface of the user's photovoltaic power generation equipment is less than the maximum charging current of the products used in Table 2-2, the DC power interface of the user's photovoltaic power generation equipment shall have a current limiting function to ensure the normal operation of the user's equipment.

- Verify that the maximum operating current of the battery-powered user equipment (inverter DC input) should be less than the maximum discharge current of the products used in Table 2-2.

The security check

- Firefighting equipment should be provided near the equipment, such as portable dry powder fire extinguisher.
- Automatic fire fighting system shall be provided for the case where necessary.
- No flammable, explosive and other dangerous articles are placed beside the battery.

3.1.4 Unpacking inspection

- When the equipment arrives at the installation site, loading and unloading should be carried out according to the rules and regulations, to prevent from being exposed to sun and rain.
- Before unpacking, the total number of packages shall be indicated according to the shipping list attached to each package, and the case shall be checked for good condition.
- In the process of unpacking, handle with care and protect the surface coating of the object.
- Open the package, the installation personnel should read the technical documents, verify the list, according to the configuration table and packing list, ensure objects are complete and intact, if the internal packing is damaged, should be examined and recorded in detail.

3.1.5 Engineering coordination

Attention should be paid to the following items before construction:

- Power line specification.
The power line specification shall meet the requirements of maximum discharge current for each product.
- Mounting space and bearing capacity.
Make sure that the battery has enough room to install, and that the battery rack and bracket have enough load capacity.
- Wiring.
Make sure the power line and ground wire are reasonable. Not easy to short-circuit, water and corrosion.

3.2 Equipment installation

3.2.1 Installation steps

Table 3-2 Installation steps

Step1	Installation preparation	Confirm that the ON/OFF switch on the front panel of unit is in the "OFF" state to ensure no live operation.
Step 2	Mechanical installation	1. Battery placement position determination
		2. Cable harness pre-installed
		3. Battery module installation
Step3	Electrical installation	1. Ground cable installation
		2. Battery module parallel cable installation
		3. Battery module total positive cable installation
		4. Battery module total negative cable installation
		5. Internal CAN communication interface connection
Step4	Battery system self-test	1. Press the ON/OFF switch to the "ON" state
		2. BMS system power-on activation
		3. Check the system output voltage
		4. Shut down the system
Step5	Connecting inverter	1. Connect total positive & total negative cable of the battery system to the inverter
		2. Connect the external CAN/RS485 communication cable to the inverter(Details as page 15)

Product Size:

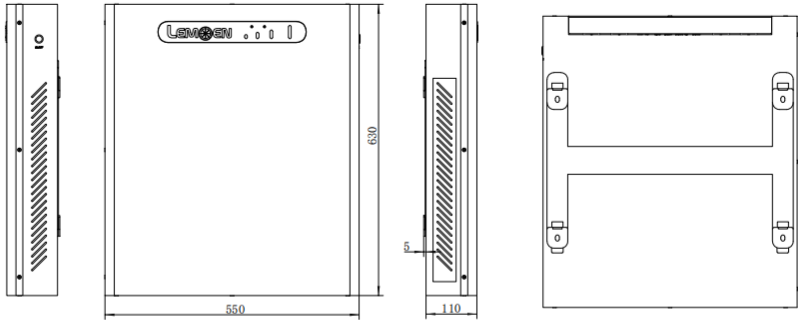

Accessories:(Optional)

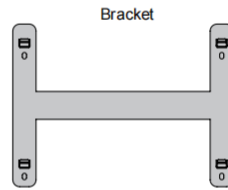
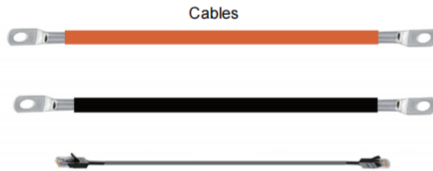

Parallel Connection Of Batteries

Connect the positive pole and positive pole in parallel, and the negative pole and negative pole in parallel, as shown in the figure below

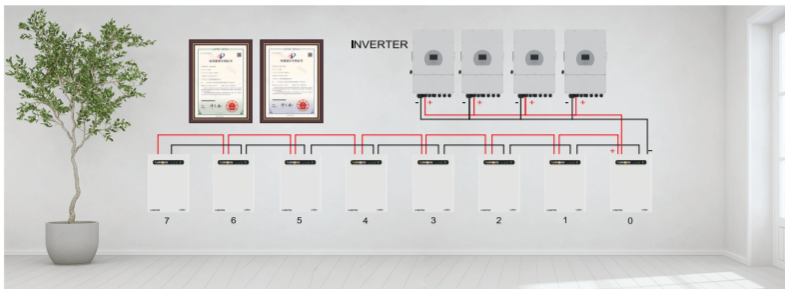

Installation Notes:

1. As shown in the figure below, press the fixed pendant on the wall surface with one hand, use a marker to draw the installation positioning hole of the fixed pendant, and use a tool to drill.

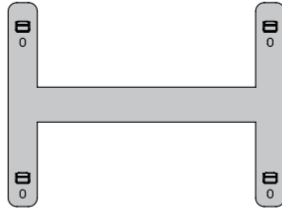

2. As shown in the figure below, fix the attached 4 M8 expansion bolts in the opening of the pendant, and tighten the nuts on the bolts.



3. Lift up the 51.2V battery box, adjust the opening of the pendant on the back of the box to align with the pendant on the wall as shown in the figure below, and then use a marker to mark the mounting ears of the box, and use tools to drill holes for the mounting ears.

Wall Mount

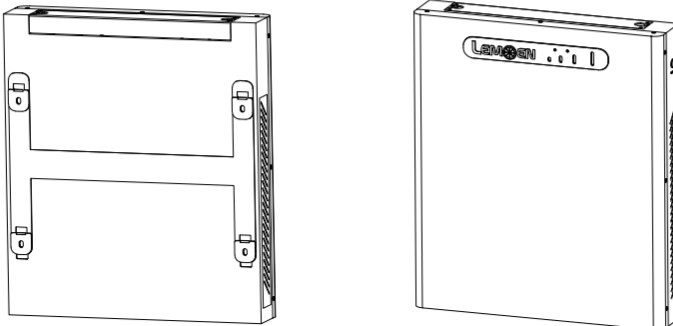

4 Communicate inverter

4.1 Method 1: Communicate factory default inverters

Step 1: Select the cables used by the inverter by the label on the communication cables. Insert the RJ45 connector of the battery end(CAN/RS485) and the inverter end(CAN/RS485) into the interfaces on both sides.

Step 2: Turn on the battery and inverter and wait until they are working properly. The battery is configured by factory default to communicate with the Voltronics, Mecer, Kodak, Phocos, Xpert Inverter (RS485 Port), DEYE, Sunsynk, SMK (Hybrid), Luxpower, Sofar, TBB inverters (CAN Port), the battery will automatically select and communicate with one of these inverters.

Step 3: After successful communication between battery and inverter, battery status will be displayed on inverter: voltage, current, SOC, temperature, etc.

4.2 Method 2: Communicate optional inverters (protocol select)

When communicating with other brands of inverters, such as Growatt, Solax, Goodwe, Sorotech, LTW, MUST, SMA, etc.

Step 1: Turn on the battery, ensure BMS is normally powered on and not in sleep state, the RS232 crystal head of the communication cable is inserted into the battery communication port, the USB end is inserted into the computer;

Step 2: Unzip the package of BMS monitoring software to the current computer (Windows Microsoft .NET Framework 2.0 or above). This software does not need to be installed independently, only the environment is satisfied, double-click the main program icon (BMS exe file) to run and use. Enter the password: green1234 (space is green, the password is correct).

Step 3: Click "Parameter information" at the top of system page, click "Read" button to read battery parameter. Select the inverter protocol at "Protocol type". Click the "Write" button to set the protocol, after the system displays the operation succeeds, protocol selection is complete (Please refer to the following pictures).



Step 4: Select the cables used by the inverter by the label on the communication cables. Insert the RJ45 connector of the battery end(CAN/RS485) and the inverter end(CAN/RS485) into the interfaces on both sides. Restart the battery and inverter. The battery will automatically communicate with the inverter corresponding to the selected protocol.

4.3 Remark of inverter protocol code

Inverter protocol code remark

RS485 Protocol			CAN Protocol		
Protocol Code	Inverter brand	Compatible (Same protocol)	Protocol Code	Inverter brand	Compatible (Same protocol)
Darfon	Voltronic Power	MOTOMA/Opti_Solar/Victron	GOODWE	GOODWE	SOLARFAM
Growatt	Growatt		PYLONTECH	PYLONTECH	DEYE/Sunsynk/LUXPower/TBB/SOFAR/ESENER(hybrid)
ESENER	ESENER (off-grid)		SOROTEC	SORO Power	Victron/SMA
SOLAX	SOLAX Power		SOLAX	SOLAX Power	
LTW	Lt-power		PV1800F	MUST Solar	
SRNE	SRNE Solar	PACE/Epever	LTW	Lt-power	
PV3500	MUST Solar		Growatt	Growatt	
			Schneider	Schneider Electric	